

• • • • • , • • • • • , • • • • • ,

() .

() .

The paper examines the current state and the need for improving sound suppressor designs for small arms to increase their efficiency. Special aspects of sound suppressors and positioning systems used within the ATO zone are reported. Information on major sound ranging systems and the status of their development in Ukraine are specified. Descriptions and specifications of sound suppressors for small arms developed in the Russian Federation are provided. The state of the world's development of sound suppressors and their characteristics for the weapon using a high-energy ammunition are specified.

It is demonstrated that high-performance sound suppressors for small arms are created in Ukraine. They are standardized using the Hartmann–Sprengr effect and have conical and spherical baffles. Conclusions are drawn and the basic lines for designing advanced sound suppressors for small arms are presented.

:

)

()

() .

1994

© • • • • • , • • • • • , • • • • • , 2015

– 2015. – 4.

()

[1].

[1-8].

[7].

(),

— « — ».

[7].

()

[6].

()

[6].

[8]. , -

. , -

.

[8]:

-

;

-

;

-

;

-

,

;

-

;

-

;

-

-

.

[9]. «

(

)

,

.

» [9].

-

,

,

.

,

-

-

.

-

-

,

,

,

,

[9].

-

,

,

,

,

.

-

,

-

,

.

,

-

,

,

[10 – 25].

Boomerang – PDCue (AAI Corp.),
10 (BBN), Gun PACS
Boomerang (Raytheon), REDOWL (I ROBOT), ISIS
(Vanderbilt University), SWATS (Qinetiq North America) – 17
, Ears VMS (Qinetiq), Sniper Egg (Ultra
Electronics), Pin Point (Cobhani Bio Mimetic System).

Met-
ravib – Pilar, Pearl Renault Tuck Defense – SLATE,
– ASLS AKSL (Reinmetall), – SADY (Rafael),
– MDA (Ferret).

() «
– » « – » (.).

87041
13.05.2013 « », «

» [26], [27 – 35].

« » « », -7 (),

« -2».

, [36 – 43]. [44], «
 » «
 - , .»
 (), « » () «
 » ().
 : suppressor, sound moderator, silencer. , silencer –
 , ,
 ; suppressor – « »;
 - , ,
 , [45].
 - « » (),
 - « » ().
 20 – 100 , 30 – 1000).
 , . 20 – 30
 7,62 , 25 – 35
 ; 160 – 165 130 – 140 , . . .
 125 – , - , .
 , , ,
 ; , .
 , , ,
 ;
 , AR-15. ,
 4 1
 4-2000 ,
 -1 .
 () , -

-1, [36].
 -1 () , (). , -
 , -
 , -
 , -
 , -

-1 200 .
 -4 -5 (.1) 5,45 × 39,0



.1 - -5



.2 - -5, Red Jacket Firearms

« » , « -
 ». -5 -
 Red Jacket Firearms (.2) BMF-17K.



.3. - -2

5,45-
 (-74) -5
 1980 .

-5



.4. - -2, -74

5,45 74, 74 , 105; 5,56 74,
 101, 102 7,62 -
 103 104.

104 647,

7,62

« ».

-2 (.3, 4).

- (.5, 6). -
 (-) [35] -

:

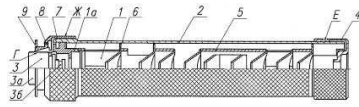

. 5 -



. 6 -

(
 -
 1,3
 -1367 « ».

600). (V -294,5 /)
 ~0,2 , ~0,32 , ~60 , ~1,7
 -1,

[47]. : Advanced Armament Corporation, AWS Systems Technology, Bowers, De Croat Tactical Armaments, Gemtech, Knight's Armament Company, Opsine, Sure Fire, SWR, Tactical Innovation, HTG, Yankee Hill Manufacturing (YHM) – , Ase Utra, BR Reflex Suppressors (), Brügger & Thomet AG (), Hausken Lyddemper (), SAI-Small Arms (), Hussh Sound Moderators ().

«Reflex Suppressor» ().

R15, M4, M16, C7, .308M62 [49],
MG34, LS26 (. 7,62×53R) [50].

– Juha Hartikka –

[39, 40].

1991 1995 Hartikka 300
Reflex.

BR-Toute Ky, Ase Utra Juha. – Ase
Utra. 60 Reflex Suppressors. [51].

1.

					()			\$	
AWS Systems Technology	THURBO-DYNEX	.50BMG	16,5	2,0		30,0	304		51
Advanced Armament Corporation	CYCLOPS	.50BMG	15,75	2,5		32,0	304	2500,0	52
HTG	Hercules	.50BMG	13,0	2,0	90,0	30,0	Inconel-6SS	1750,0	53
AWS Systems Technology	THUNDER TRAP	.338L	10,15	1,625	29,0	30,0	304 / Ti-	1595,0	51
GEMTECH		.338LM	12,0	2,0	27,0	39,0	Ti-304 / Inconel718		54
Advanced Armament Corporation	TITAN	.338LM	10,0	2,0		38,0	Inconel718, 316LSS		55
Advanced Armament Corporation	TITAN-SS	.338LM	10,0	1,85		38,0	Ti-Grades 5,9		55
HTG	Posidon	.338	10,1	1,5	35,0	25,0	Inconel 304 /	855,0	53
YHM	Phantom	.338LM	10,15	1,625	33,0	28,0	304 /		56

, , -
 , -
 303 304, -
 Grades 5,9, Inconel-718.
 36,0 .
 - , -
 , -
 , -
 « » 1994 , -
 , -
 , -
 - 88.057.004-98,
 (. . -
). -
 , -
 , -
 , -
 , -
 , -
 10 , -
 36 . - 32 -



. 7 - " (100 - 300 .)
 . 7 [45] -
 [45]. -

(), -74 -

« » (-132 -5,45) [57, 58].

— () :

— , -

— (;)

— (,), ,

— ,

(5,45; 5,56 7,62).

— :

— ;

— ;

— ;

— ()—

— , , -

— . .

— [60], [61]

— « » [62].

— [43].

— . 8. -12 .12-7,62;



-19 .12-7,62 -



« » , -



+7° . -

. 8— -12 .12-

1— -11 .12-5,45; 2— -12 .12-7,62; 7,62

3— -19 .12-7,62 7,62 .

— 14x1 . -

: Ø43 , L=224 . -

-19 .12-7,62 -

Blaser R93, 7,62 (.30-06). -

- 14x1
: Ø43 , L=231



« » .9.

7,62



(~36)
(.8, .3).

-19 .12-7,62

.9-

-11 .12-5,45

« »

« »

-2° .

-74 (5,45).

- 24x1,5

: Ø43 , L=195

Ø7,0
: 66 , 28 , 28 , 28 , 17

Ø5,0 . Ø7,0

Ø3,0

28 - 32 ,

-11 .12-5,45.
5,45-

- 74.

- « » - 5,45

(5,45x39) , .1974 .

- « » - 5,45

7 1.

-74,

32,6 , -74 5,45 -11 .12-5,45 -
 - 32,1 . -
 « » -
 -11 .12-5,45 () -

35 .
 - 250 -
 25 . - 400 15 .
 360 () -

(.10).

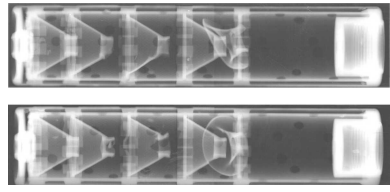

.10 -
 -11 .12-5,45 -

~45°.
 « »

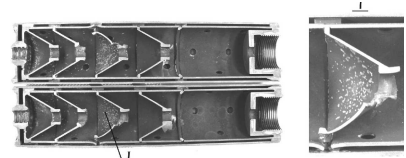

.11 - -11 .12-5,45



.12 -
 -11 .12-5,45

(-
 .11,
 - .12).

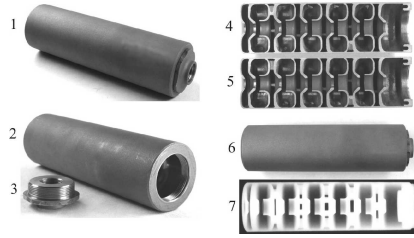

1, 6 – ; 2 – ; -12 .12-7,62,
 3 – ; 4, 5 – ; -19 .12-7,62
 7 – ASE Ultra SL7-7,62.
 . 13 – ASE Ultra SL7-7,62
 . 13.

ASE Ultra SL7-7,62
 1 ASE Ultra SL7-7,62
 15%

– 5,45 – -11 .12-5,45;
 – 7,62 – -19 .12-7,62.
 . 3, – 2. . 8, . 1
 2

	19 .12-7,62	11 .12-5,45
-	32 36	28 32
,	11	11
,	238	195
,	43,0	43,0
,	435 (750)	400 (690)
	14×1; 15×1; 16×1; 18×1; 9/16"-24; 14×1 ()	24×1,5; 18×1; 1/2"-284; 1/2"-20 14×1 ()
	(/)	(/)

- 7,62 - Blaser, Browning Bar, SAKO, Manlicher, - ;
 - 5,45 - -74 , -74,
 -16, Blaser, M4A1, SAKO, .

. 14 [61]

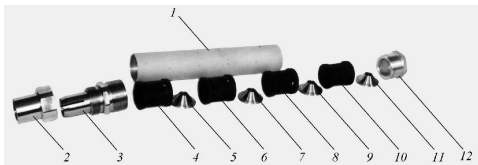
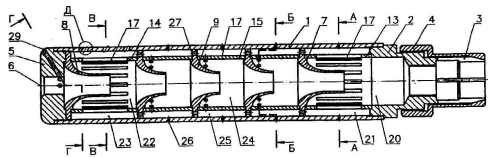

. 14 - [61] . 14. . 14 [61]

: 1 - ; 2 - ; 3 - ; 4, 6, 8, 10 -
 ; 5, 7, 9, 11 -
 ; 12 - .

5,56 , 7,62 .

(160 , ~43,0)

[57].

-74 , -132 -5,45,

[63]

[64].

[63] . 16 [64].

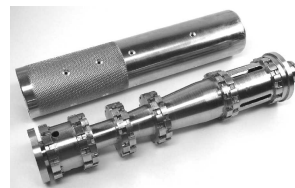
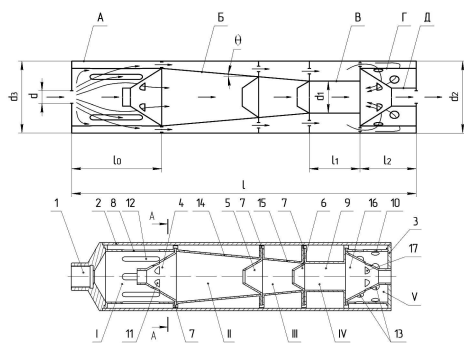

. 15 -

. 16 -

[63]

[64]

. 17.



. 17 -

[64]

7,62

32 - 34

(Grade 5, Grade 9

),

1-0; 5; 5-1; 6.



.18 -

[42]

[42]

5.45×39

.18 [42]

[43].

7.62,

-83, ASE UTRA,

18,

-94.

«

»

5,6

;

5,45



().

500

(~ 3)

.19 -

[65]

« » . -
 . -
 (. 19).

[65].

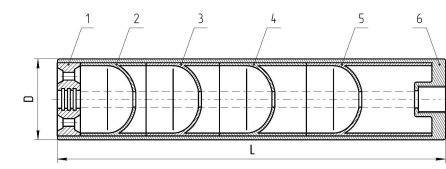

. 20 -
 . -
 . -
 . -

-
 . -
 ; () -
 ; -

-
 ; -
 . -

-
 . -
 . -

60 – 90°, -
 [66]. -

0,4 – 0,5 , -
 , -
 , -

1,2

0,1

12

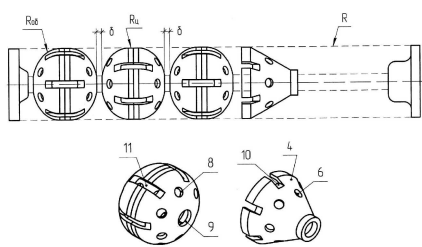

. 21 -

[66]

. 21

30°

. 21

0,4 - 0,5

1,2

[66].

[66].



. 22 –

[66].

5,45; 5,56 7,62
36

[66].

1.

2.

3.

— , ; —
 (,).

1. // . — 2009. — 4. — . 18 – 20.
2. 10 / . — . : , 2011. — 320 .
3. « », 2007. — 300 .
4. // . — 2009. — 3. — . 43 – 48.
5. / . . . , . . . // . — 2009. — 4. — . 30 – 34.
6. . « » [. — : <http://www.alternathistory.org.ua/akusticheckie-sistemy-obnaruzhenia-ognya-sova-sleshit-pulu>.
7. // / . . — 2010. — 4(26). — . 56 – 60.
8.] — : <http://www.politico.ua/blogpost115980>.
9. / . . // . — 2014. — 1(37). — . 5 – 11.
10. // . — 2011. — 4. — . 45 – 53.
11. // . — 2012. — 56, 29 .
12. [] — : http://www.army.guide.com/rus/article_911.html.
13. [] — : <http://www.zhelezaka.com/news.php?id=2987>.
14. Boomerang Warrior-X. [] — : <http://www.ohrana.ru/equipment/technique/1630>.
15. [] — : <http://www.zakhoi.ru/forum/showthread.php21=5518G2&s=2209f5b23db921cea25e179cd7f8626f>.
16. [] — : <http://www.mixednews.ru/archives/12907>.
17. [] — : <http://www.topwar.ru/37817-akusticheskie-sistemy-opredeleniya-vystrela.html>.
18. / . . // . — 2008. — 5. — . 52 – 56.
19. [] — : <http://www.autoconsulting.com/ua/article/php?sid=30908>.
20. 2285272 , G01S 5/18, G01S 3/80. / ; " " (RU), " " (RU). — 2005102338/09 ; . 31.01.2005 ; . 10.10.2006, . 28. — 12 . 21. 2416103 , G01S. / " " (RU), " " (RU), " — 2009126000 ; . 06.07.2009 ; . 10.04.2011, . 2. — 13 . 22. 2406964 , F41H 13/00. () / ; . — 2008153 956/02 ; . 29.12.2008 ; . 20.12.2010, . 35.

23. Patent 5544129 USA, Int.Cl⁶ G01S 5/20. Method and Apparatus for Determining the General Direction of the Origin of a Projectile / Niall B. McNelis, AAI Corporation ; Assignee: GTE Internetworking Incorporated, Cambridge, Mass. – 298178 ; Filed: Aug. 30, 1994 ; Date of Patent Aug. 6, 1996. – 13 p.
24. Patent 5930202 USA, Int.Cl⁶ G01S 5/18. Acoustic Counter-Sniper System / *Gregory L. Duckworth, James E. Barger, Douglas G. Gilbert* ; Assignee: GTE Internetworking Incorporated, Cambridge, Mass. – 08/974657 ; Filed: Nov. 19, 1999 ; Date of Patent: Jul. 27, 1999. – 19 p.
25. Patent 6178141 USA, Int.Cl⁷ G01S 5/18. Acoustic Counter Sniper System / *Gregory L. Duckworth, James E. Barger, Douglas G. Gilbert* ; Assignee: GTE. Internetworking Incorporated, Cambridge, MA (US). – 09/322359 ; Filed: May. 28, 1999 ; Date of Patent : Jan. 23, 2001. – 37 p.
26. 87041 G01C 3/00. / « ».- u201305951 ; 13.05.2013 ; 27.01.2014, 2.- 7
27. / , // – 2001. – 1.- . 31 – 34. [.] : <http://www.narodka.com.ua/10117-pochuti-ta-znishiti>.
28. // – 2015. – 3(47) – . 98 – 102. /
29. // – 2012. – . 3- .- . 48 – 54. //
30. // – 2012. – . 3- .- . 31 – 36. //
31. // – 2015. – 4.- . 51 – 57. //
32. // – 2013. – 1(32) – . 5 – 10. [.] .- : <http://www.echo.msk.ru/news/1442032-echo.html>.
33. [.] .- : http://www.army.guide.com.rus/article_911.html.
34. / , , , , 2008. – 303 : / , , , 2011. – 340
35. *Paulson Alan C.* Silencer. History and Performance. Volume 1. Sporting and Tactical Silencer / *Alan C. Paulson*. – USA, Boulder, Colorado : Paladin Press, 1996. – 412 p.
36. *Paulson Alan C.* Silencer. History and Performance. Volume 2. QQB, Assault Rifle and Sniper Technology / *Alan C. Paulson, N. R. Parker, Peter G. Kokalis*. – USA, Boulder, Colorado : Paladin Press, 2002. – 429 p.
37. *Parker N. R.* Firearm Suppressor Patents, Volume 1, United States Patents / *N. R. Parker*. – USA, Boulder, Colorado : Paladin Press, 2004. – 373 p.
38. / , – . : , 1979.
39. (2008 – 2013 .) / , , // – 2013.– 4.- . 16 – 31.
40. / , , , , , // – 2013.– 1.- . 78 – 95.
41. 28653 – 2009. , : , 2009. – 180 [.] .- : <http://www.gutierrez.3dn.ru/blog/silencers/2011-06-11-6>.
42. [.] .- : <http://www.russianguns.ru/forum/index.php/topsc.194.html>.
43. [.] .- : <http://www.guns.connect.fi/rs/index.html>.
44. [.] .- : <http://google.com.ua/translate?hl=ru=>.
45. [.] .- : <http://www.guns.connect.fi/rs/Krsgraf.html>.
46. *Juha Hartikka* / *Hartikka Juha* // – 2010. – 159. – . 52 – 57.

51. AWC, , 2012. – 11 p. []. – : AWC.systech.com.
52. Advanced Armament Corporation, 2012. – 31 .
53. HTG Silencers Product Catalog, , HTG, 2012. – 35 .
54. Word Class Silencers, GEMTECH, 2015/2016, 2015. – 36 .
55. Advanced Armament Corporation, 2015. – 31 .
56. Yanke Hill Machine Company (YHM), 2010. – 25 .
57. / . . , . . . // . – 2012. – 2. – .50 – 76.
58. 95693, , (2011.01) F41A 21/30, (2006.01) F41 A17/00. / ; 2009 13359; . 22.12.2009; . 25.08.2011, . 6. – 12 .
59. / // . – 2014. – 1. – .3 – 10.
60. 97016, , F41A 21/30 (2006.01), F41 A17/00. / ; 201000488; . 23.04.2010; . 26.12.2011, . 24. – 7 .
61. / // . – 2011. – 1. – .86 – 98.
62. 201310602, , F41A 21/30 (2006.01). / ; . 02.03.2013.
63. 105545, , F41A 21/30, F41 A21/34. / ; 201000488; . 20.06.2012; . 11.11.2014, . 10. – 8 .
64. / // . – 2013. – 2. – .64 – 71.
65. / // . – 2012. – 1. – .28 – 37.
66. 109381 , F41A 21/30 (2006.01). / ; . – 201410885 : . 06.10.14; . 10.08.2015, . 15. – 8 .
- 06.10.2015,
28.10.2015